

## NKXR17-Z-XL

Needle roller/axial cylindrical roller bearing

Schaeffler ID:  
0507917700000

Needle roller/axial cylindrical roller bearings NKXR...-Z, axial component, single direction, to DIN 5429, with end cap, for grease lubrication

X-life

### Technical information

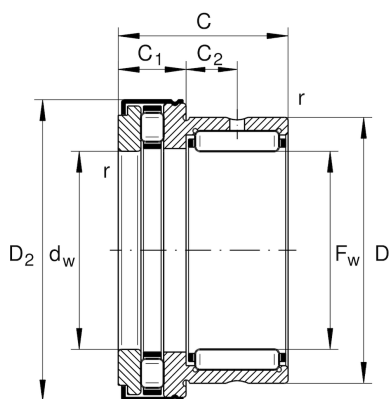
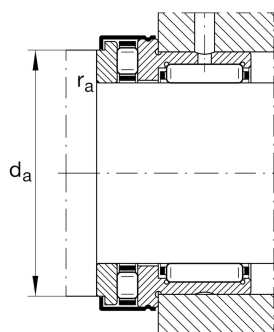

### Main Dimensions & Performance Data

$F_w$	17 mm	Bore diameter
$D$	26 mm	Outside diameter
$C$	25 mm	Height
$C_r$	13,500 N	Basic dynamic load rating, radial
$C_{0r}$	15,000 N	Basic static load rating, radial
$C_a$	16,000 N	Basic dynamic load rating, axial
$C_{0a}$	33,500 N	Basic static load rating, axial
$C_{ur}$	2,800 N	Fatigue load limit, radial
$C_{ua}$	4,700 N	Fatigue load limit, axial
$n_G$	12,000 1/min	Limiting speed
$n_{gr}$	5,500 1/min	Reference speed
	53.68 g	Weight

### Dimensions

$D_{1\max}$	31.2 mm	Maximum outside diameter flange
	IR14X17X17-XL	Suitable inner rings IR
$D_{2\max}$	31.2 mm	Maximum outside diameter flange
$C_1$	9 mm	Width of the axial bearing component
$C_2$	8 mm	Distance to lubrication hole
$d_w$	17 mm	Bore diameter of shaft washer
$r_{\min}$	0.3 mm	Minimum chamfer dimension

### Mounting dimensions

$d_a$	25.7 mm	Mounting dimension shaft shoulder
$r_{a\max}$	0.3 mm	Maximum recess radius

### Temperature range

$T_{\min}$	-30 °C	Operating temperature min.
$T_{\max}$	120 °C	Operating temperature max.